

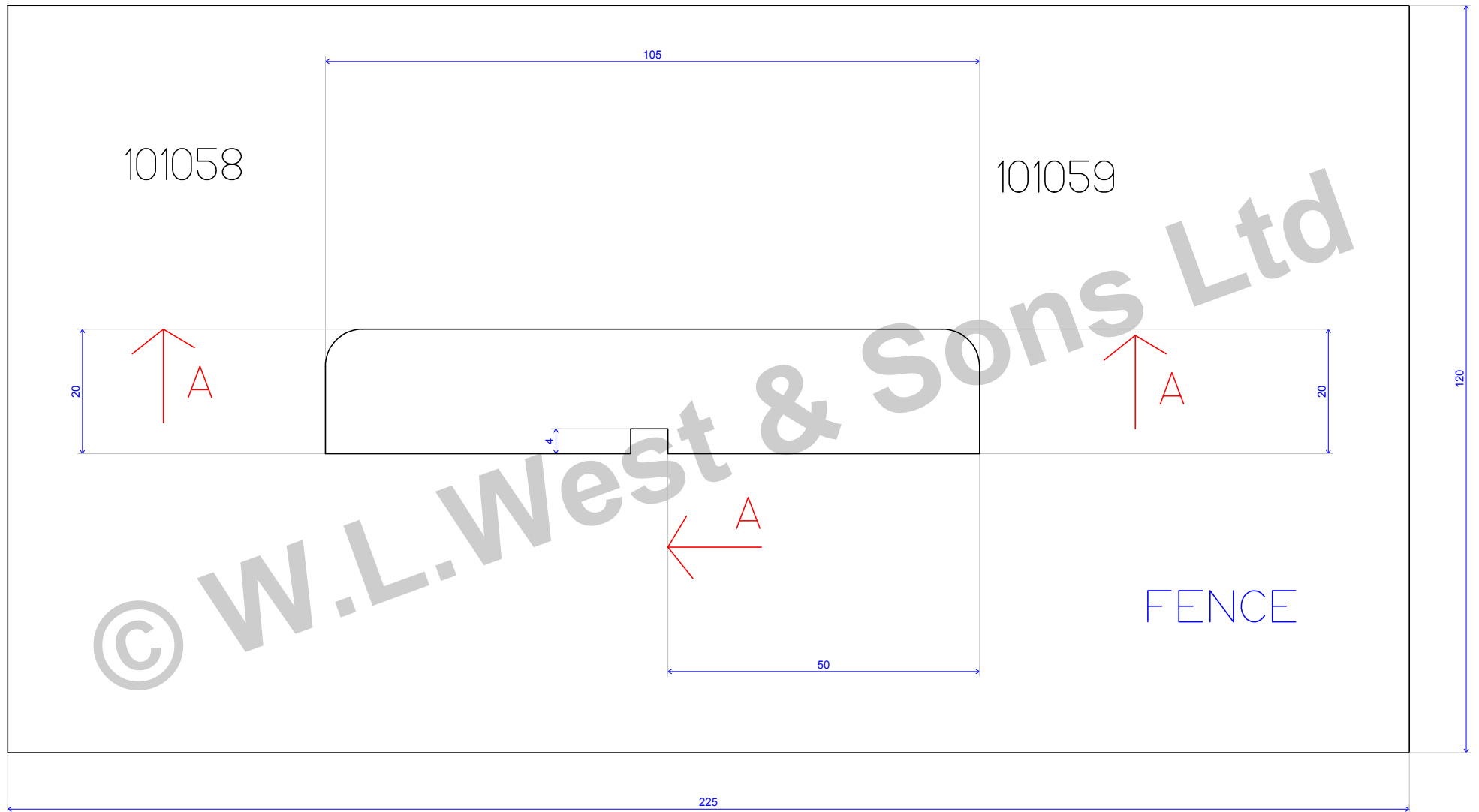

	WLW 2 x 12MM RADIUS DECKING	Scale : 1.235
20/05/09		

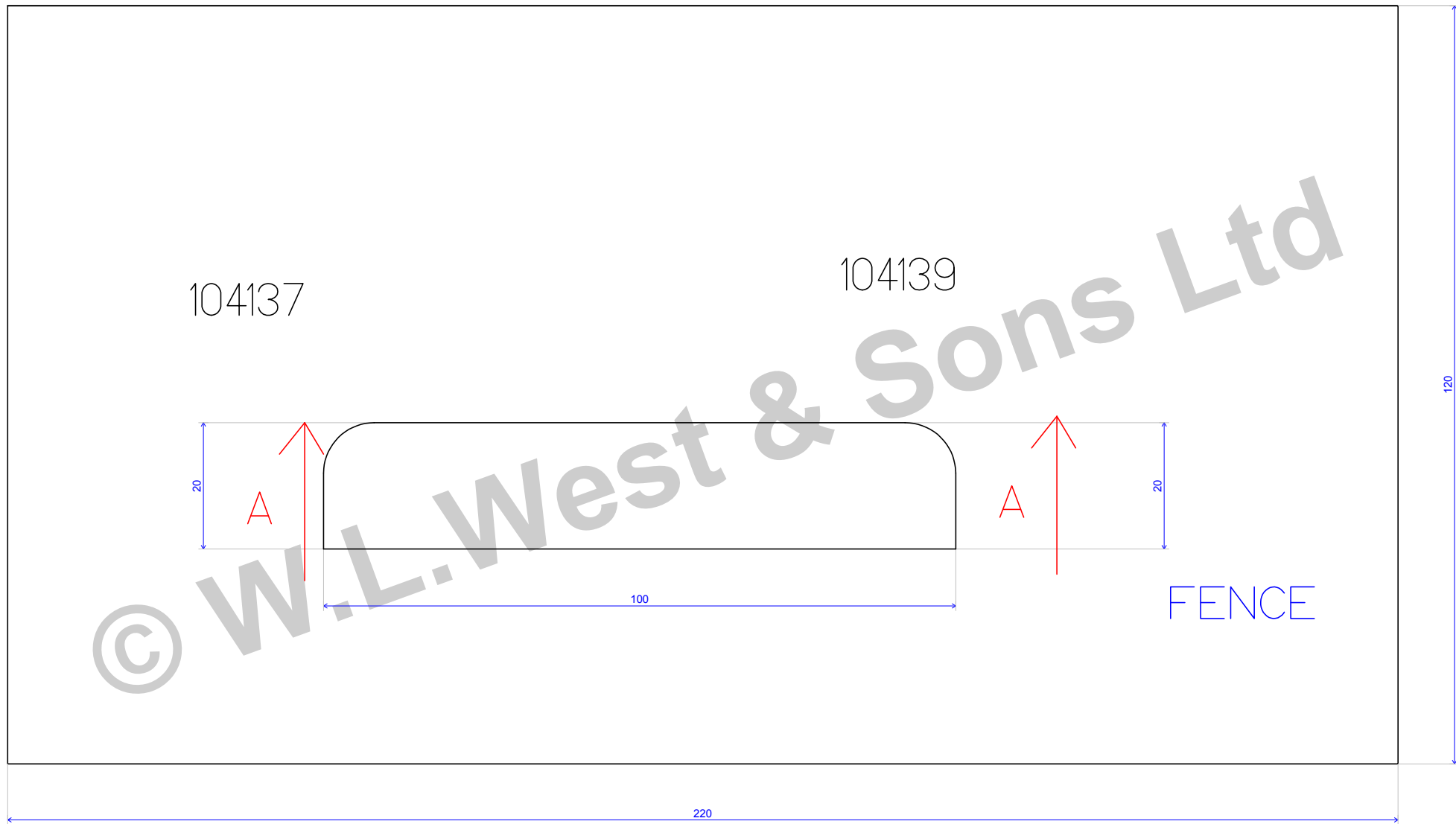

	WLW 2 x 6MM RADIUS DECKING	Scale : 1.098
20/05/09	Box 101	



	WLW 2 x 8MM RADIUS DECKING	Scale : 1.123
20/05/09	Box 104	

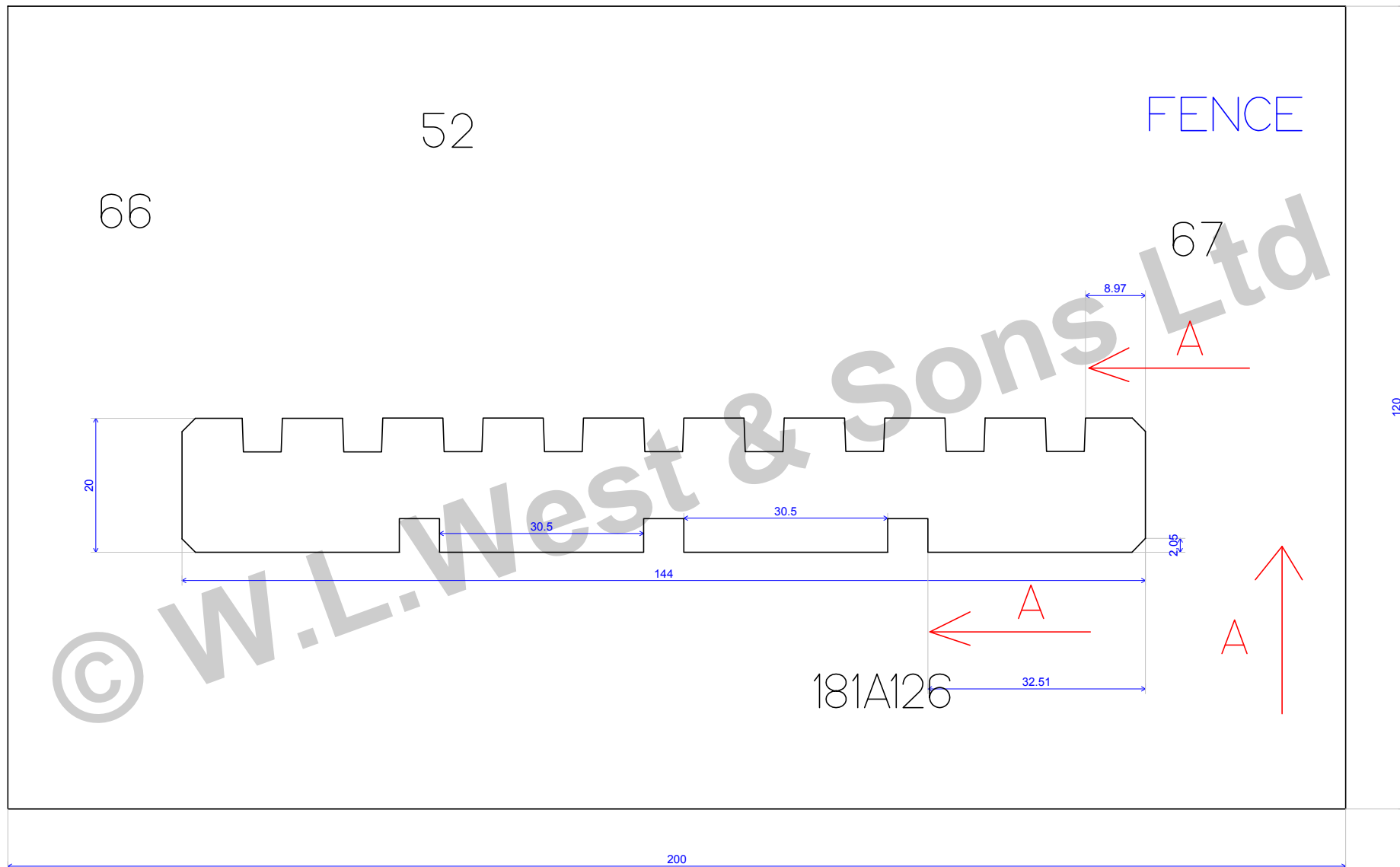

20/05/09

WLW 9 GROOVE DECK
Box 181 A

Scale : 1.164

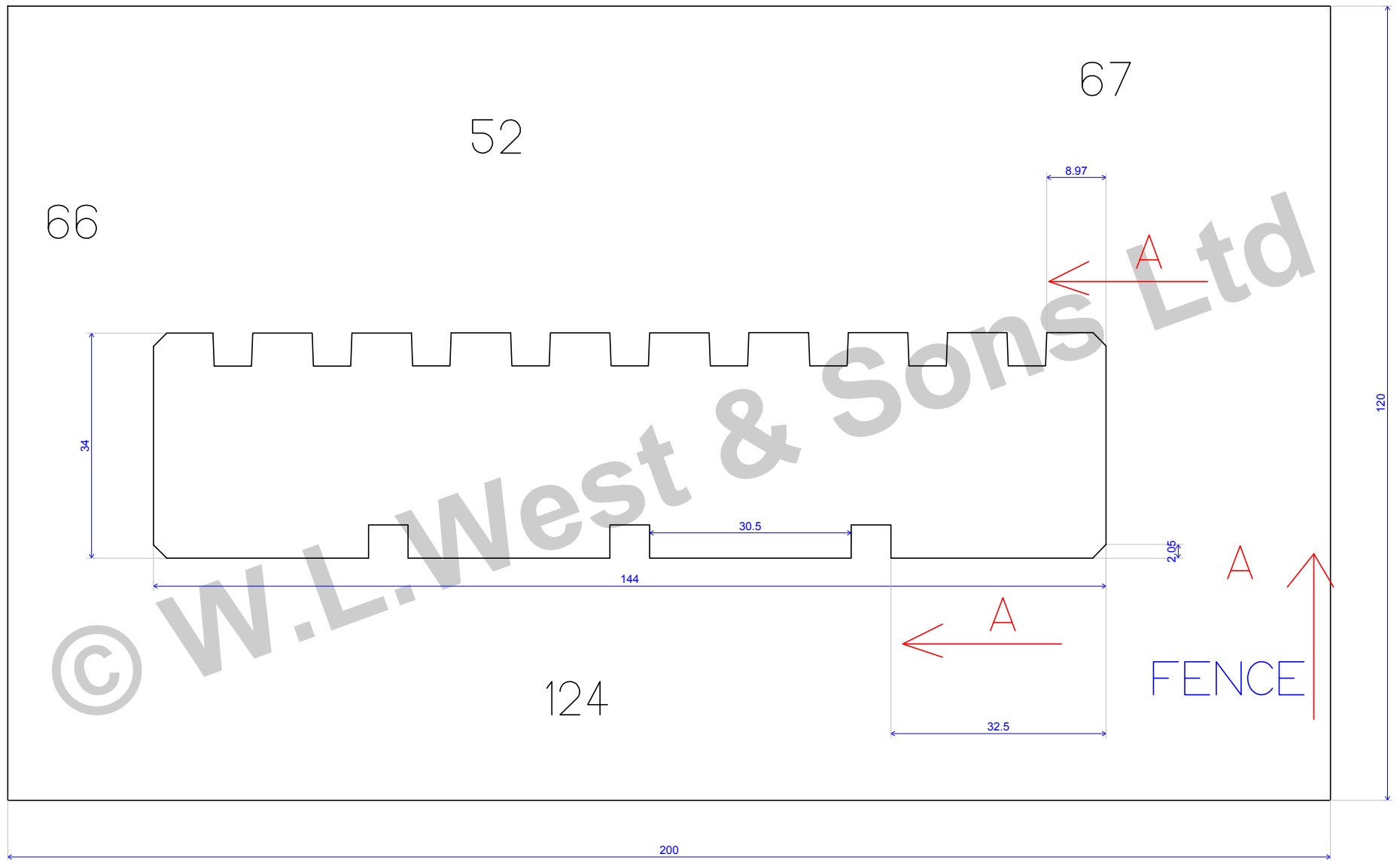

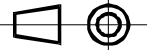
		
	WLW 9 GROOVE DECK	Scale : 1.164
20/05/09	Box 181 C	

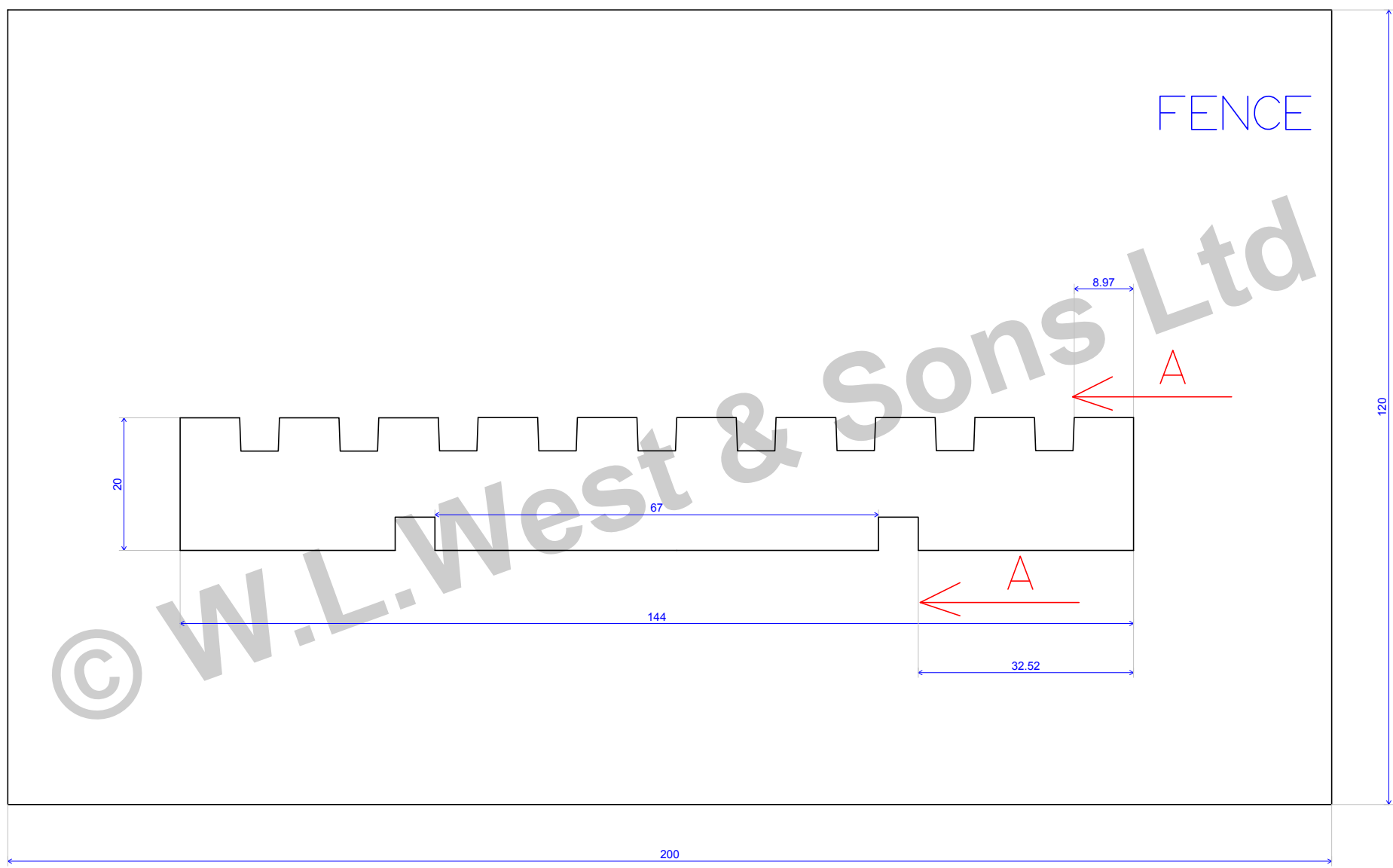

© W.L. West & Sons Ltd

FENCE

	WLW 9 GROOVE DECK	Scale : 1.164
20/05/09	Box 181	

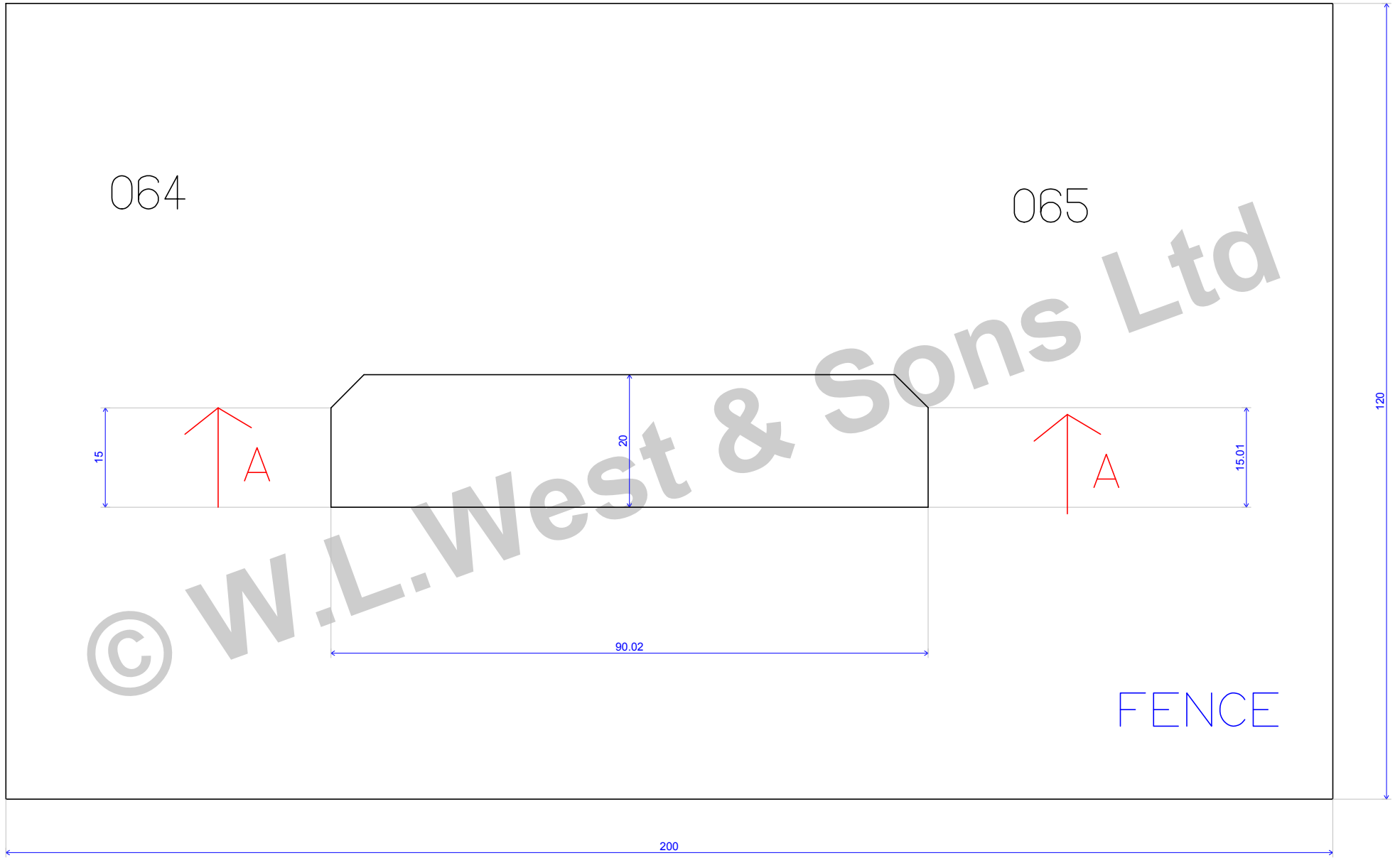

		
	WLW CHAMPH DECK	Scale : 1.235
19/05/09		

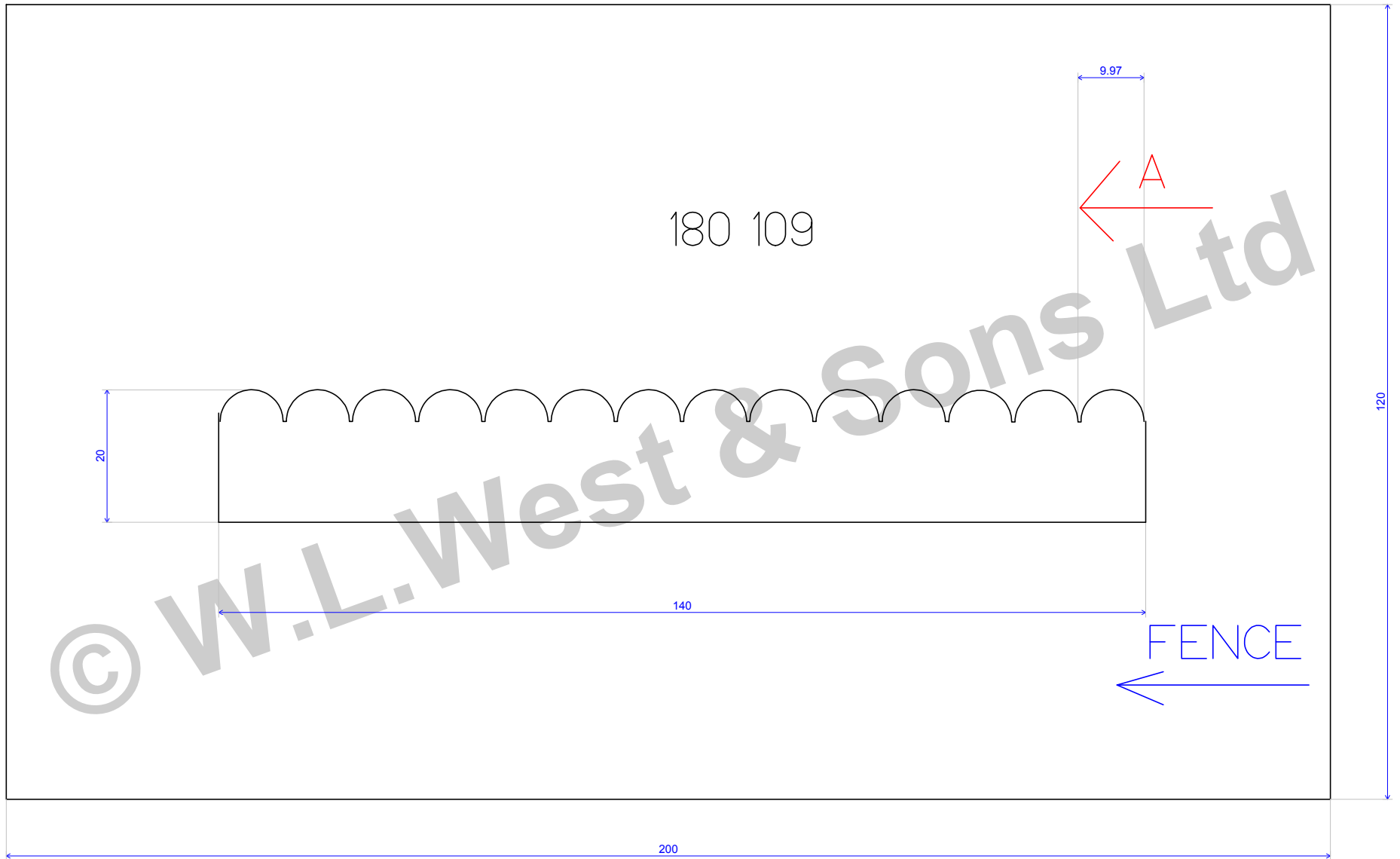

		
	WLW CHAMPH DECK 1	Scale : 1.164
19/05/09	Box 180	

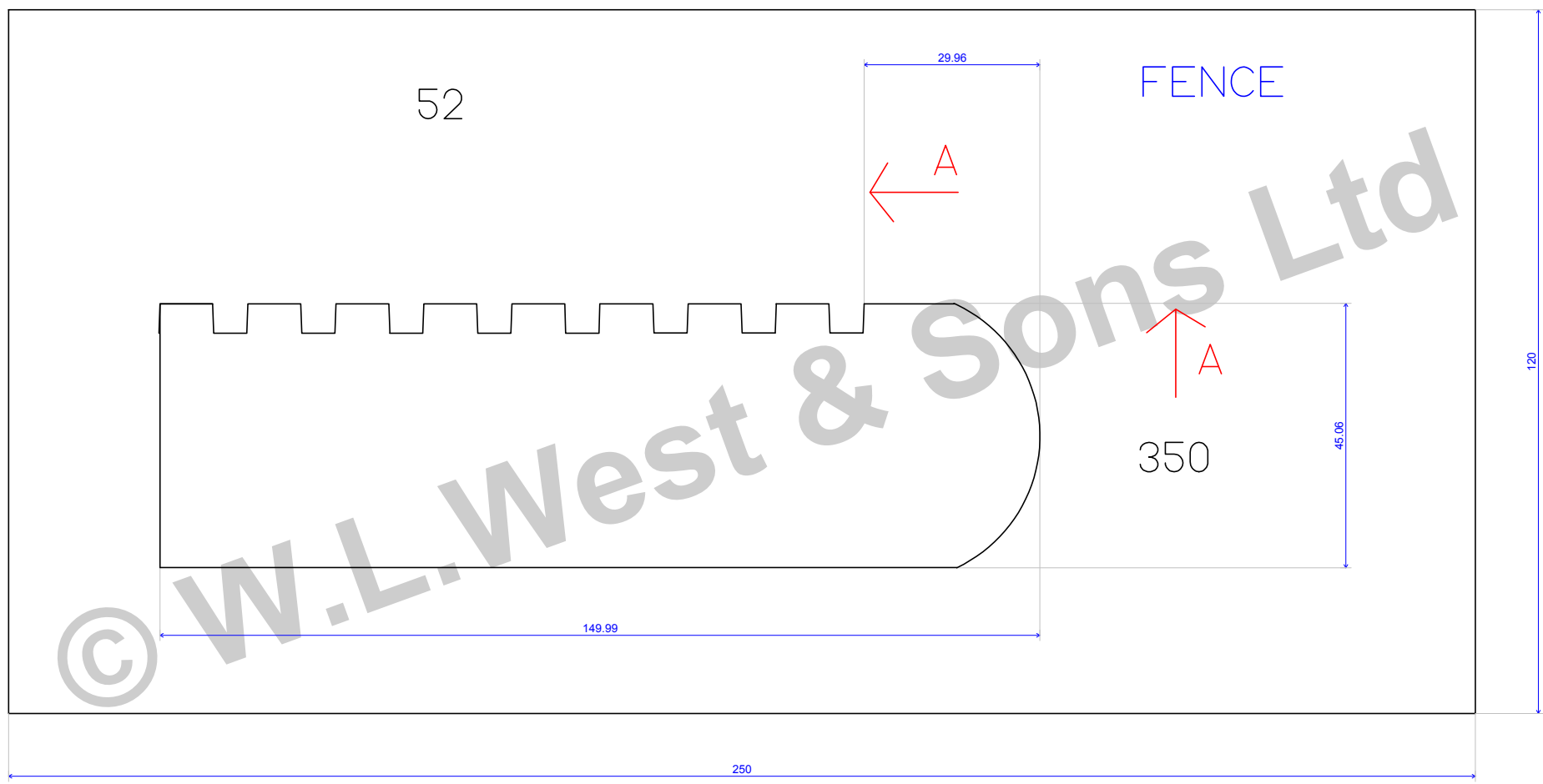

	WLW 9 GROOVE STEP	Scale : 0.931
20/05/09	Box 179	

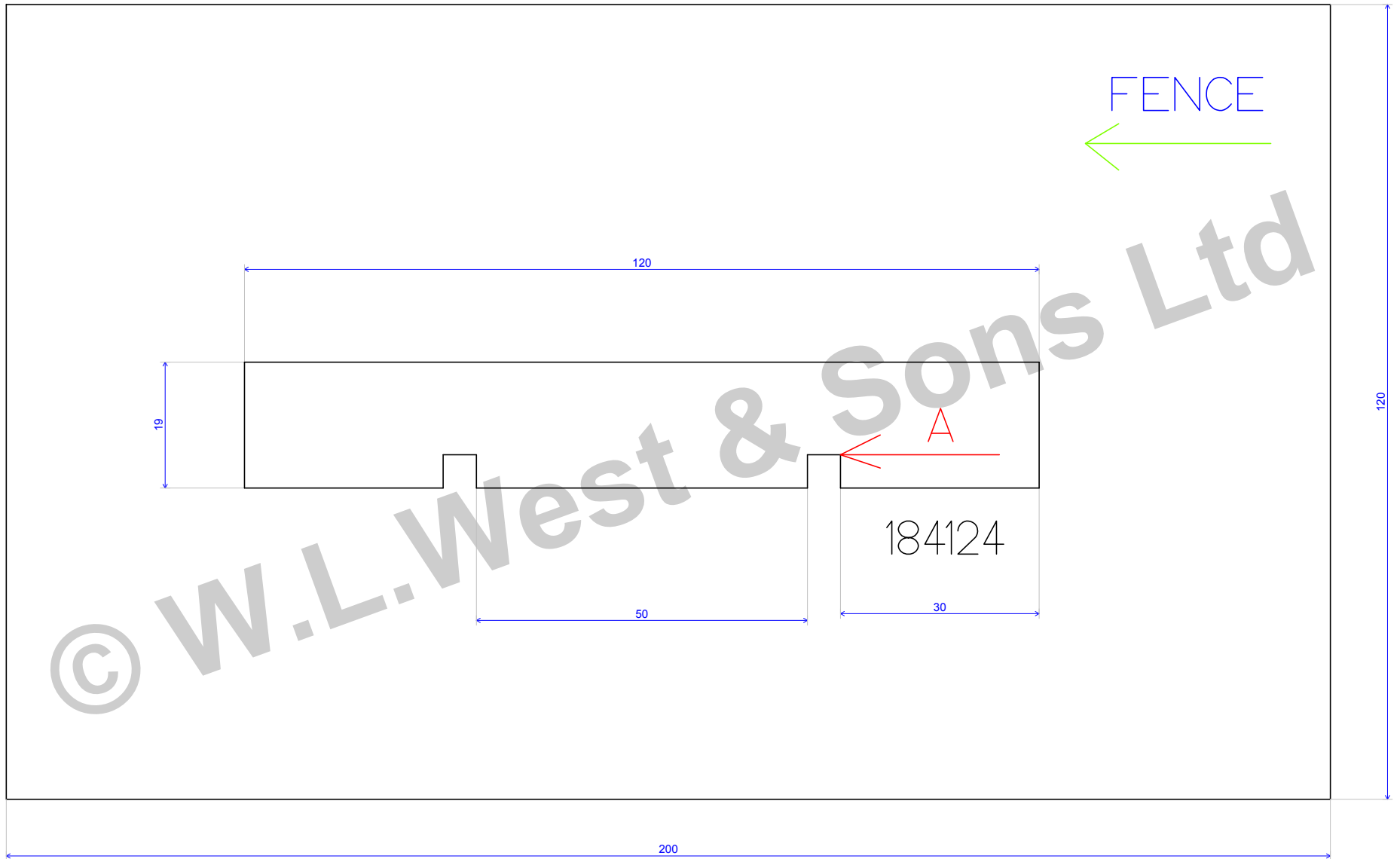

		
	WLW PLAIN DECK	Scale : 1.164
20/05/09	Box 184	

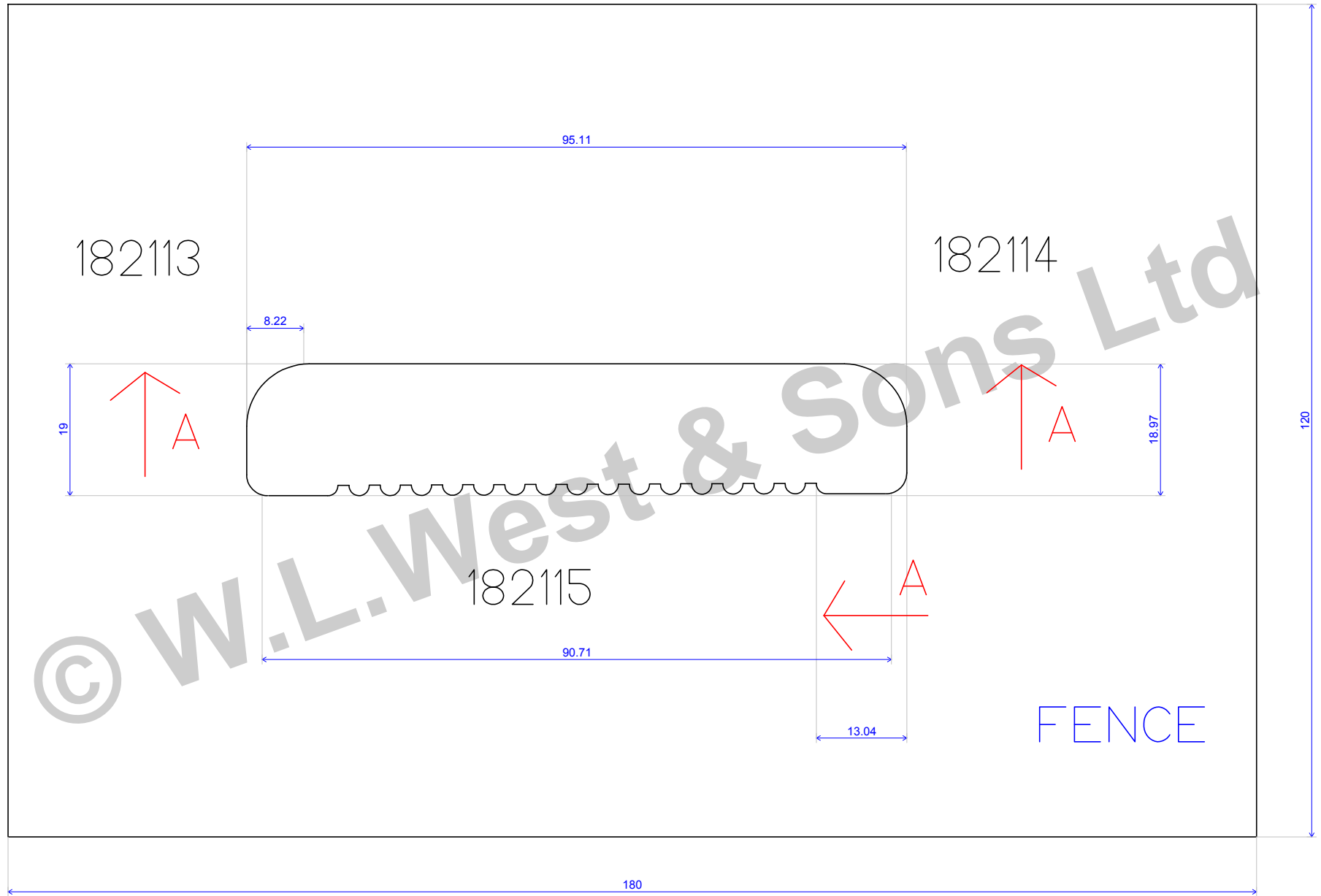

		
	WLW SMALL RIDGE DECK 2	Scale : 1.257
19/05/09		